

INSTALLATION INSTRUCTIONS FLEXIBLE MOULDINGS

ORAC[®]
DECOR

INSTALLATIE VAN FLEXIBELE LIJSTEN | INSTALLATION DES MOULURES FLEXIBLES |
INSTALLATION VON FLEXIBELE LEISTEN | INSTALACIÓN MOLDURAS FLEXIBLE |
ISTRUZIONI PER L'INSTALLAZIONE DI MODANATURE FLESSIBILI | ИНСТРУКЦИЯ
ПО УСТАНОВКЕ ГИБКИЕ ПРОФИЛИ

UM303 - 06/2023

Product image: SX180F



WWW.ORACDECOR.COM
>> INSTALLATION

1

Ready?

ATMOSPHERE



Storage and installation conditions: Store profiles and adhesives at room temperature and wait 24 hours before installing.
Opslag- en plaatsingsvoorwaarden: Plaats profielen en lijmen 24 uur vóór de installatie op kamertemperatuur.
Conditions d'installation et de stockage: Stockez les profils et les colles à température ambiante 24 heures avant la pose.
Lager- und Installationsbedingungen: Profile und Kleber 24 Stunden vor Verlegung bei Zimmertemperatur lagern.
Condiciones de almacenamiento y de instalación: Colocar molduras y adhesivos en el lugar 24 horas antes de la aplicación.
Condizioni di stoccaggio e di installazione: conservare profili e adesivi a temperatura ambiente e attendere 24 ore prima dell'installazione.
Обязательно оставьте стеновые панели и клей на 24 часа перед монтажом в помещении под отделку.

Ready? Set? Go!

✓ **INSTALLATION
GUARANTEE**

SURFACE



Dust free
Stofvrij
Sans poussière
Staubfrei
Libre de polvo
Privi di polvere
Удалите пыль



Sand and wash surface
Schoor en reinig de ondergrond
Poncez et nettoyez la surface
Schleifen und reinigen Sie den Untergrund
Superficie lisa y limpia
Superficie carteggiata e pulita
Очистите поверхность



Flat wall & ceilings
Vlakte wand en plafond
Mur et plafond plats
Plane Wand und Decke
Paredes y techos lisos
Pareti e soffitti
Выровняйте стены и потолок



Dry
Droog
Sec
Trocken
Seco
Asciutto
Высушите



No grease
Vetvrij
Sans graisse
Fettfrei
Sin grasa
Assenza di grasso
Обезжирьте

2

Set?

DECOFIX ADHESIVES



Online glue calculator
Online lijmcalculator
Calculateur de colle en ligne
Online Klebrechner
Calculadora de adhesivos online
Calcolatore di colla online
Калькулятор клея



Interior, porous and dry surface
Binnen, poreuze en droge ondergronden
Pose à l'intérieur, surfaces poreuses, pièces non humides
Innen, poröse/saugfähig, und trockene Untergründe
Interior, superficies porosas y secas
Superficie interna, porosa e asciutta
Для внутренних работ, пористых и сухих поверхностей



Heavy profiles
Zware lijsten
Grandes moulures
Grosse Profilen
Perfiles pesados
Profili pesanti
Тяжёлые профил

or
of
ou
oder
o
oppure
или



Exterior, non-porous or humid surface
Buiten, niet-poreuze of vochtige ondergronden
Pose à l'extérieur, surfaces non poreuses ou environnement humide
Außen, nicht-poröser/saugfähige Untergrund oder Feuchträume
Exterior, superficies non porosas o ambientes húmedos
Superficie esterna non porosa o umida
Для внешних работ, непористых или влажных профилей

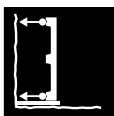

Seal wall/ceiling
Verbinding muur/plafond
Collage mur/plafond
Verbindung Wand/Decke
Adherencia techos/paredes
Collante per parete/soffitto
Стены/потолки



DecoFix Pro Strong, water-based acrylic installation adhesive

FDP500 310 ml > 7 - 8 m
10.5 oz > 23 - 26 ft
FDP600 4200 ml > 65 - 110 m
142 oz > 213 - 361 ft



or
ou
oder
o
oppure
или



DecoFix Power Very strong MS-Polymer-based installation adhesive

FDP700 290 ml > 7 - 8 m
9.8 oz > 23 - 26 ft

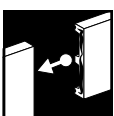

Joints between mouldings
Verbinding tussen profielen
Joints entre les profils
Nahtverbindungen zwischen Profilen
Uniones de los perfiles
Giunte tra i profili
Стыки между профилями



DecoFix Ultra Polymer-based white adhesive

FX400 270 ml > min. 80 m
9.13 oz > min. 262 ft

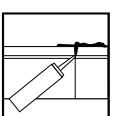

Finish seams with DecoFiller
Werk naden af met DecoFiller
Finissez les coutures avec DecoFiller
Nähte mit DecoFiller versiegeln
Acabar las costuras con DecoFiller
Rifinire le giunte con DecoFiller
Заделайте все швы с помощью DecoFiller



DecoFiller Ready to use lightweight acrylic filler

FL300 310 ml > 30 m
10.5 oz > 98 ft



INSTALLATION INSTRUCTIONS FLEXIBLE MOULDINGS

Also see general instructions for mounting | Zie ook de algemene instructies voor montage | Voir aussi les instructions générales pour montage | Siehe auch allgemeine Instruktionen für Montage | Ver instrucciones generales para montaje | Vedi anche le istruzioni generali per il montaggio | Также смотрите общие инструкции по установке

ONLY FULL GUARANTEE WITH DECOFIX

VOLLEDIGE GARANTIE ENKEL BIJ GEBRUIK VAN DECOFIX
GARANTIE TOTALE UNIQUEMENT AVEC COLLE DECOFIX
VOLLSTÄNDIGE GARANTIE NUR BEI DER VERWENDUNG VON DECOFIX
GARANTÍA COMPLETA SOLO SI SE UTILIZA DECOFIX
GARANZIA COMPLETA SOLO CON DECOFIX
ГАРАНТИЯ НА ПРОДУКЦИЮ ДЕЙСТВУЕТ ТОЛЬКО ПРИ ИСПОЛЬЗОВАНИИ КЛЕЯ DECOFIX

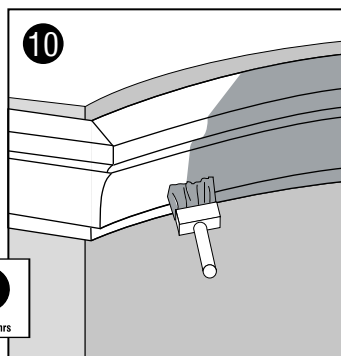
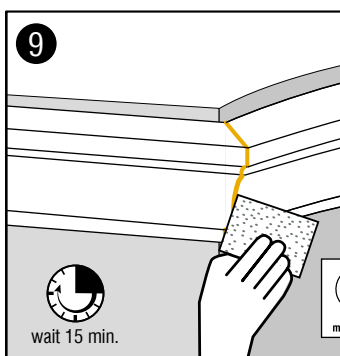
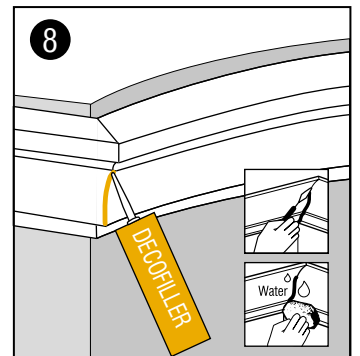
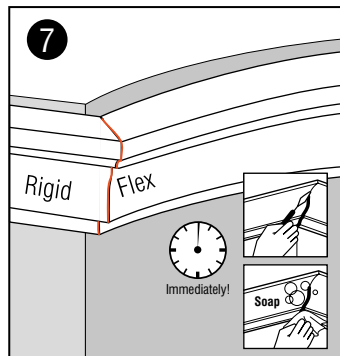
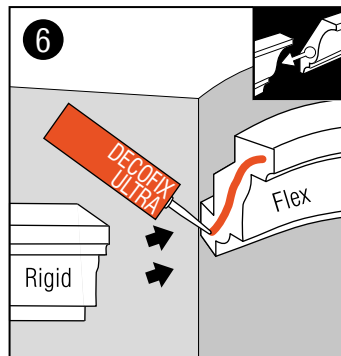
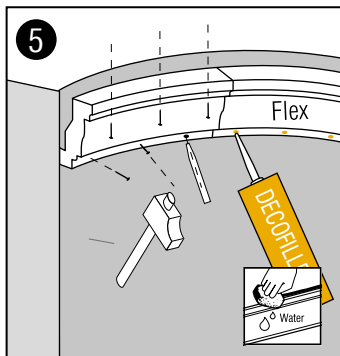
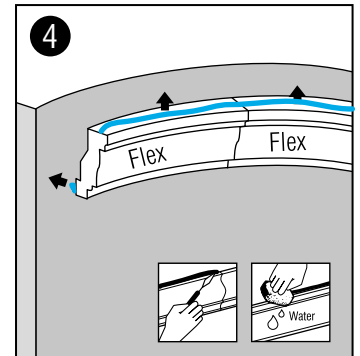
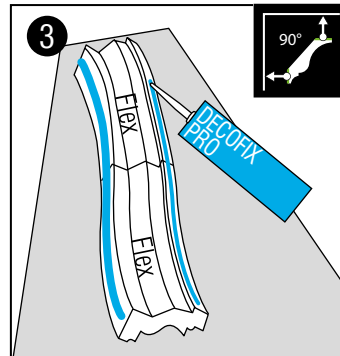
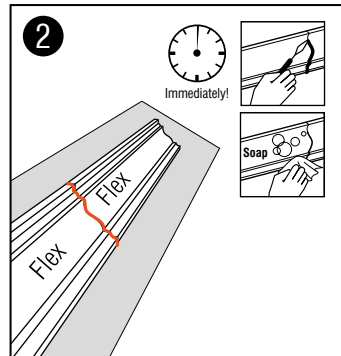
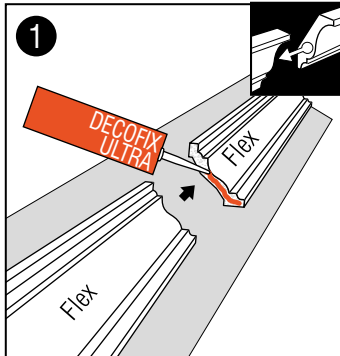

OVERVIEW ORAC FLEX

Overview radius of bending

Overzicht straal van buigingen
 Aperçu du rayon de courbure
 Übersicht Biegeradius
 Resumen radio de curvatura
 Panoramica raggio di curvatura
 Обзор радиусов

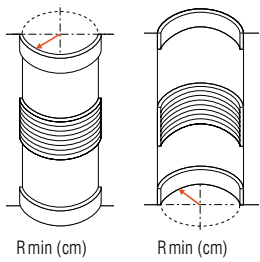

R min (cm)

R min (cm)

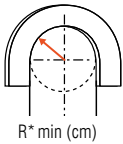

R* min (cm)

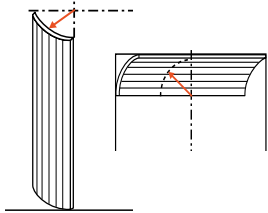

R** min (cm)

Flex Radius	R min (cm)	R* min (cm)	Flex Radius	R min (cm)	R* min (cm)	Flex Radius	R min (cm)	R* min (cm)	Flex Radius	R min (cm)	R* min (cm)	Flex Radius	R min (cm)	R** min (cm)
C211F	250		CX100F	200		SX104F	40		DX174F	60	300	W108F	30	40
C213F	280		CX106F	360		SX105F	30		P3020F	50	180	W109F	30	40
C215F	160		CX109F	160		SX118F	40		P4020F	40	200	W110F	30	40
C217F	380		CX110F	180		SX137F	40		P4025F	70		W111F	30	40
C220F	400		CX123F	280		SX138F	40		P5021F	20	70	W114F	30	40
C230F	150		CX124F	160		SX155F	30		P7070F	30	230	W116F	30	40
C240F	270		CX127F	240		SX157F	35	260	P8020F	40	130	W119F	30	40
C250F	70		CX132F	70		SX162F	20	80	P8030F	20	70			
C304F	250		CX188F	110		SX163F	35		P8040F	30				
C321F	140		CX189F	90		SX165F	40		P8050F	80	200			
C325F	300		CX190F	30	130	SX172F	35		P9010F	40	310			
C326F	500		CX199F	200		SX173F	45		P9050F	20	60			
C331F	420					SX180F	45		P9900F	20	250			
C333F	300					SX182F	35	100	PX103F	20	80			
C334F	380					SX183F	40		PX120F	30	110			
C339F	380					SX184F	45		PX144F	20	220			
C341F	400					SX187F	40		PX175F	30	80			
C373F	100					SX194F	25	80	PX198F	70				
C901F	600					SX195F	30		PX201F	30	80			
C902F	600								PX202F	60	150			
									PX209F	20	70			

CONSTRUCTION EXAMPLES

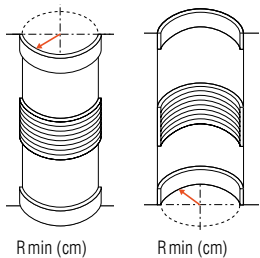

SX180F | SX180



SX183F | SX183

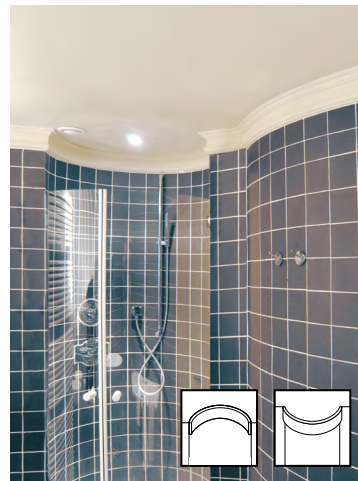

C321F | C321

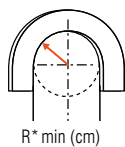

PX103F | PX103A | PX103
C338B



CX190 | W110



P9010F | P9010

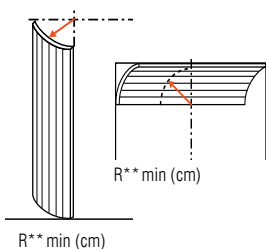

W110F | W110
W121 | W123 | W120 | W122



W109F | W109